

2017-2018

RR-20090

RR-20091



LUMI SOLUTIONS

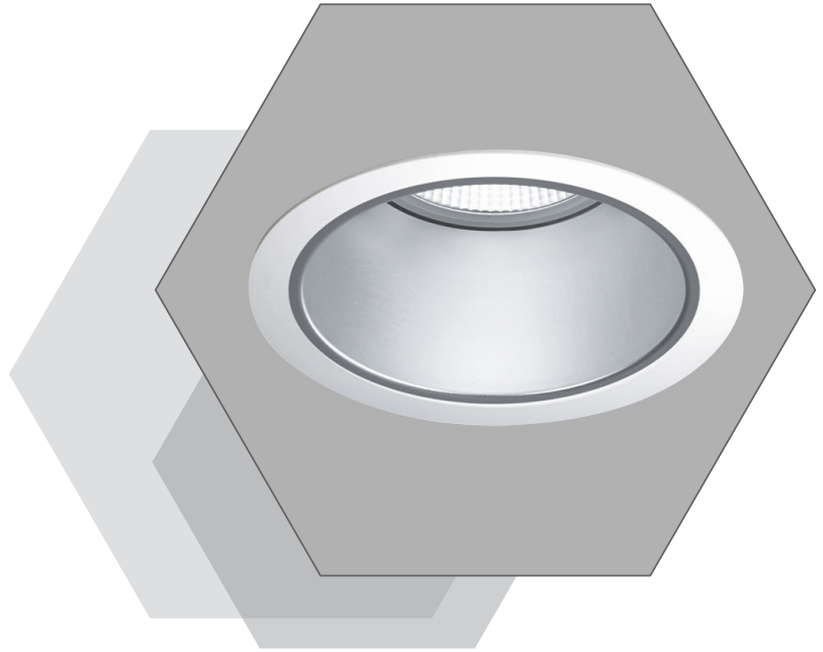
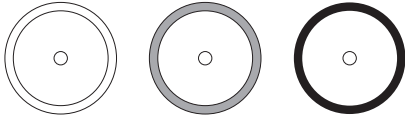

RR-20090 / RR-20091

KEHYS

Teräs

LED-RUNKO

Alumiinivalu, pulverimaalattu

HEIJASTIN

Alumiini, anodisoitu hopea

LED

COB

KÄYTTÖJÄNNITE

220-240V AC, 50-60Hz

VÄRI- LÄMPÖTILA (K)	OTTO- TEHO (W)	LÄHTÖTEHO (W)	HYÖTYSUHDE (lm/W)	VALOTEHO FLUX (lm)	ULOSTULO- JÄNNITE	VÄRINTOISTO- INDEKSI (CRI)	ANTOVIRTA
RR-20090							
4000K	45W	40W	89 lm/W	3,962 lm	35V DC	80	1,150mA DC
3000K	45W	41W	81 lm/W	3,620lm	35V DC	80	1,150mA DC
RR-20091							
4000K	55W	50W	82 lm/W	4,532lm	36V DC	80	1,400mA DC
3000K	55W	49W	76 lm/W	4,159 lm	35V DC	80	1,400mA DC

KÄYTTÖLÄMPÖTILA

-20 - +35°C

ELINIKÄ

50,000 tuntia 25°C

VÄRILÄMPÖTILA

3,000K, 4,000K

RR-20090 / RR-20091

MITTAKUVA / VALONJAKO

COB 45W 4,000K

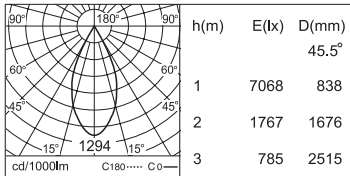

COB 45W 3,000K

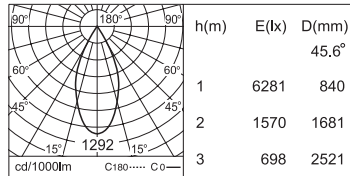

COB 55W 4,000K

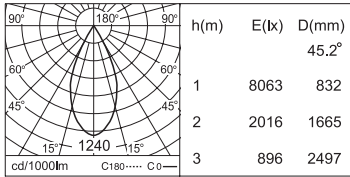

COB 55W 3,000K

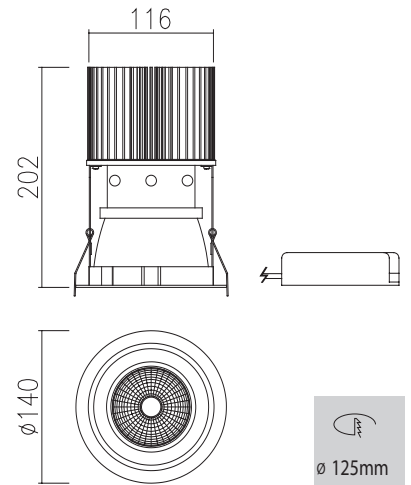
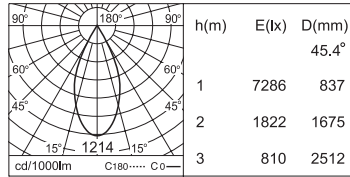

LumiSolutions Oy

YHTEYSTIEDOT

Harjutie 14
03100 Nummela
Finland

www.lumisolutions.fi
info@lumisolutions.fi
+358 10 581 7860

